

Postoperativ smertebehandling efter sectio

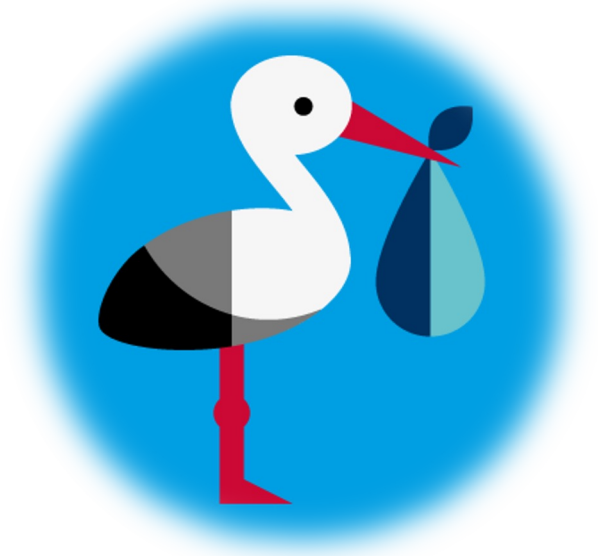

Gør vi det godt nok?

Kim Lindelof, ovl. Anæstesi JMC RH

SECTIO

- Meget lille 'Audit', RH 2021
- Opslag i journal
- 15 mg/pat oral morfin eqv. Efter sectio
- 58% postoperativ opioid

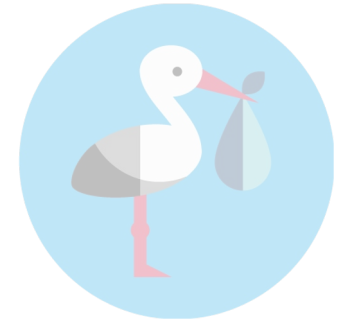

Take home

- Doseret medicin skal dokumenteres

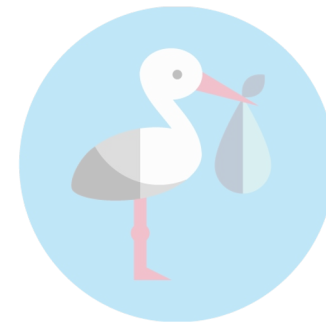

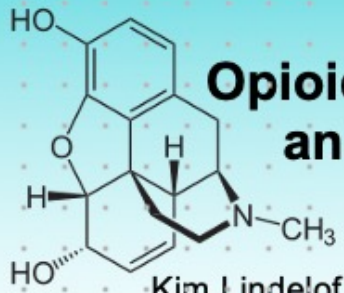

Opioid Consumption after Emergency and Elective Caesarean Section

Kim Lindelof, Christian K. Hansen, Rune Frederiksen, Jens Børglum
 Department of Anesthesiology, Roskilde Hospital, Denmark



Cumulated postoperative opioid (oral Morphine equivalent)

	12h; median (IQR)	24h; median (IQR)	Total; median (IQR)
Elektive CS (n=214)	20 (15;30) (0-162,5)	30 (20;47,1) (0-172,5)	40 (20;60) (0-250)
Emergency CS (n=36)	20 (10;37,5) (0-180)	28,8 (20-45) (0-190)	32,5 (20;50) (10-200)

Section

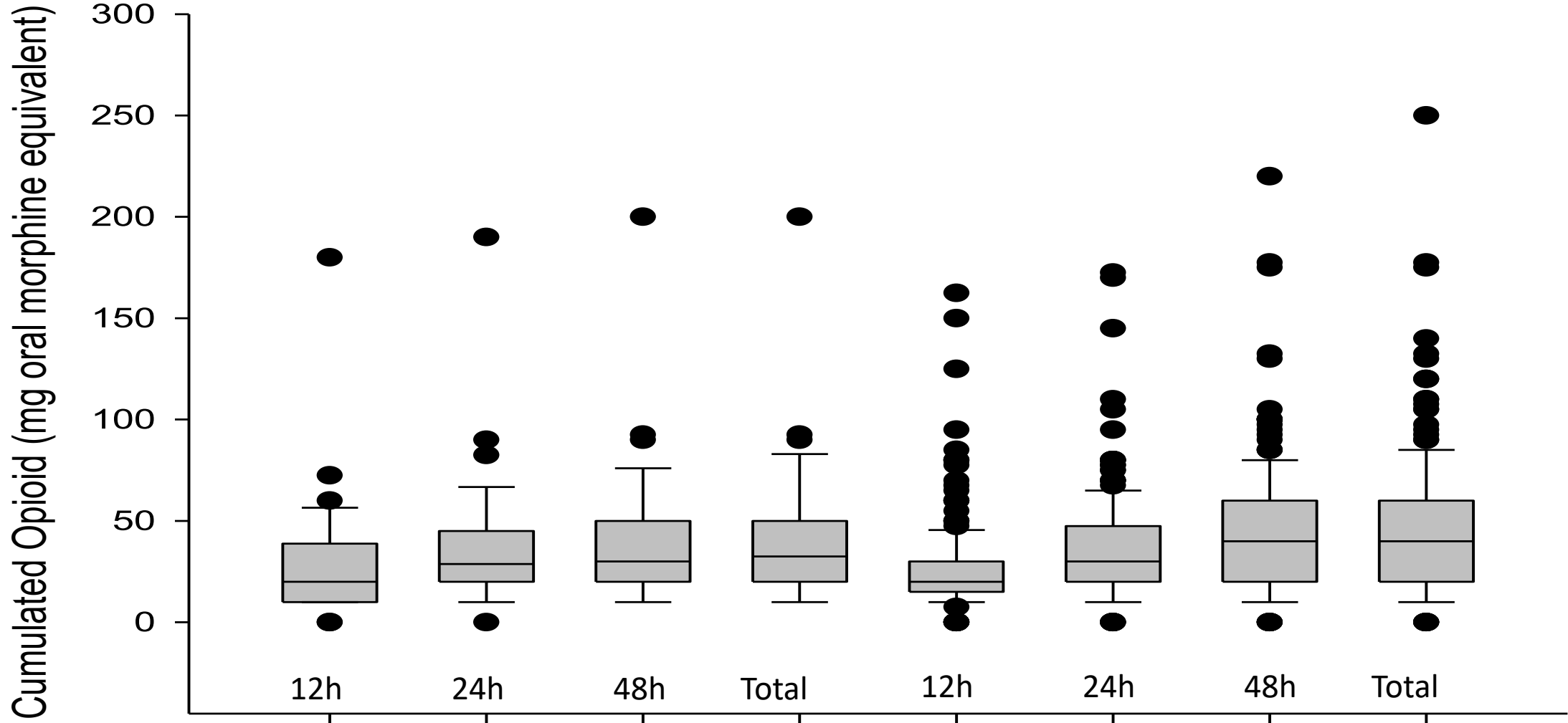

Cumulated postoperative opioid consumption (oral morphine equivalent) for elective caesarean section (n=214) and emergency (n=36); hours after surgery

Take home

- Doseret medicin skal dokumenteres
- Meget stor variation i behovet for opioid efter kejsersnit



Take home

- Doseret medicin skal dokumenteres
- Meget stor variation i behovet for opioid efter kejsersnit
- Patienten skal bedøves ordentligt

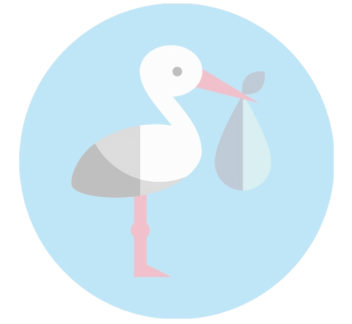

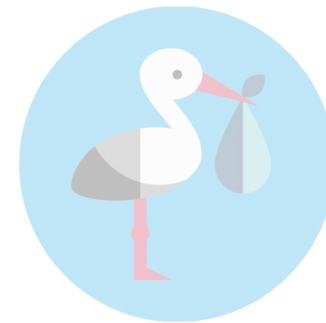

Hvor tilfredse/tilpasse er
danske kvinder
med deres fødsel ved kejsersnit?



Metode: Spørgeskema-undersøgelse

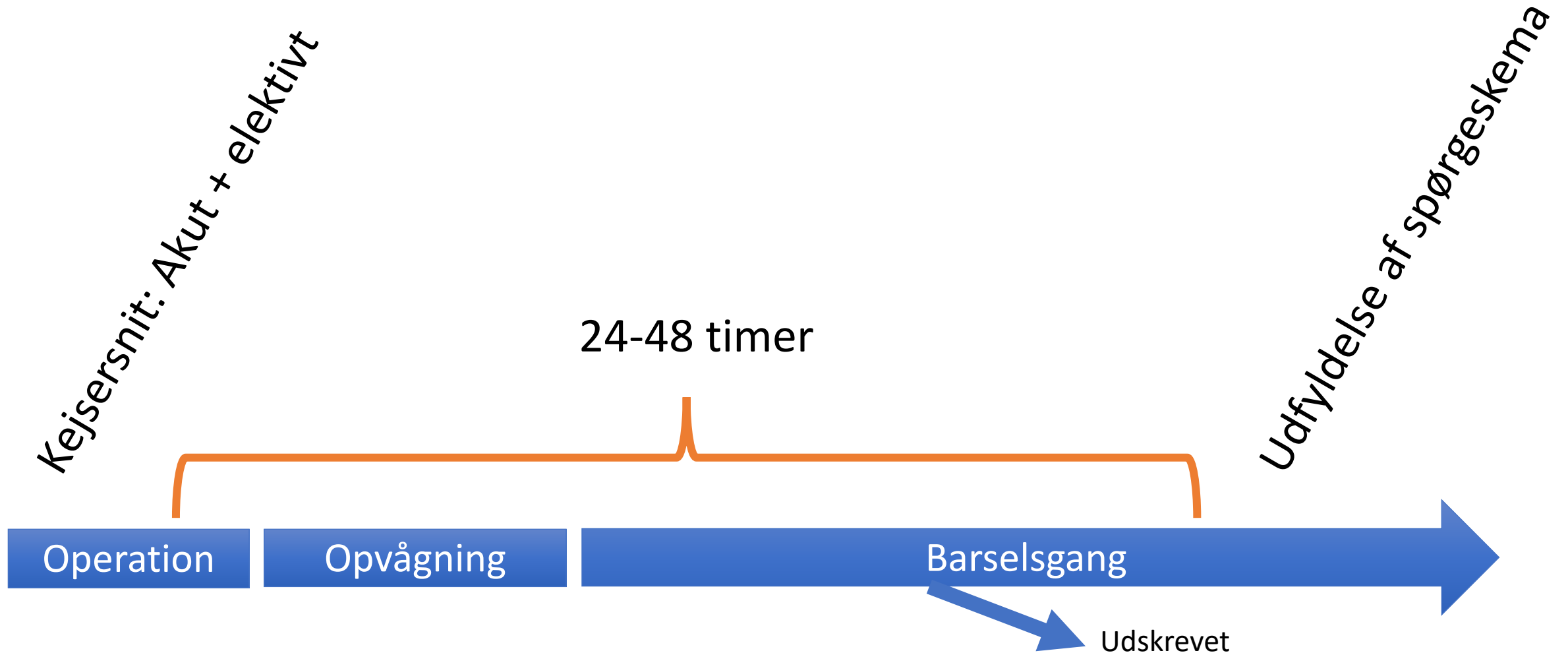

Site	Personer
Hillerød	Patricia Duch
	Kathrine Smith Grønback
Herlev	Renee Bøgeskov
	Julie Wiis
Hvidovre	Lars Møller Pedersen
	Erik Gade
Rigshospitalet	Kim Lindelof
	Kim Ekelund
Roskilde	Anne Wikkelsø
	Iben Onsberg Hansen
Odense	Mette Andersson
	Klaus Kristensen
Kolding	Caroline Bach Biering
	Anne Craveiro Brøchner
Aabenraa	Lisbeth Holmgaard Quitzau
	Kathrine Dueholme
Aarhus	Rajiv Gambhir
	Deepti Jain

Tak!



Hvordan har du haft det siden dit kejsersnit?

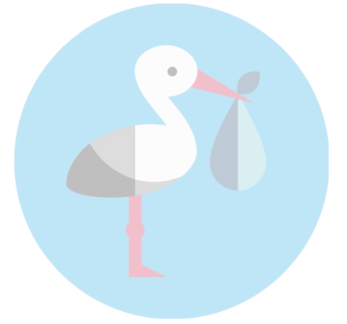

Jeg har haft meget kraftige smerter i perioden efter mit kejsersnit

Meget enig	<input type="checkbox"/>	<input type="checkbox"/>	<input type="checkbox"/>	<input type="checkbox"/>	<input type="checkbox"/>	<input type="checkbox"/>	<input type="checkbox"/>	<input type="checkbox"/>	<input type="checkbox"/>	<input type="checkbox"/>	Meget uenig
------------	--------------------------	--------------------------	--------------------------	--------------------------	--------------------------	--------------------------	--------------------------	--------------------------	--------------------------	--------------------------	-------------

Jeg har haft moderate smerter i perioden efter mit kejsersnit

<input type="checkbox"/>	<input type="checkbox"/>	<input type="checkbox"/>	<input type="checkbox"/>	<input type="checkbox"/>	<input type="checkbox"/>	<input type="checkbox"/>	<input type="checkbox"/>	<input type="checkbox"/>	<input type="checkbox"/>	<input type="checkbox"/>
--------------------------	--------------------------	--------------------------	--------------------------	--------------------------	--------------------------	--------------------------	--------------------------	--------------------------	--------------------------	--------------------------

Jeg har haft kvalme og/eller opkast i perioden efter mit kejsersnit

<input type="checkbox"/>	<input type="checkbox"/>	<input type="checkbox"/>	<input type="checkbox"/>	<input type="checkbox"/>	<input type="checkbox"/>	<input type="checkbox"/>	<input type="checkbox"/>	<input type="checkbox"/>	<input type="checkbox"/>	<input type="checkbox"/>
--------------------------	--------------------------	--------------------------	--------------------------	--------------------------	--------------------------	--------------------------	--------------------------	--------------------------	--------------------------	--------------------------

Jeg har haft meget kraftige smerter i perioden efter mit kejsersnit

Jeg har haft moderate smerter i perioden efter mit kejsersnit

Kulderystelserne var ubehagelige

<input type="checkbox"/>	<input type="checkbox"/>	<input type="checkbox"/>	<input type="checkbox"/>
--------------------------	--------------------------	--------------------------	--------------------------

Jeg har været velbefindende og har haft det godt

<input type="checkbox"/>	<input type="checkbox"/>	<input type="checkbox"/>	<input type="checkbox"/>
--------------------------	--------------------------	--------------------------	--------------------------

Jeg har været i stand til at gå omkring

<input type="checkbox"/>	<input type="checkbox"/>	<input type="checkbox"/>	<input type="checkbox"/>
--------------------------	--------------------------	--------------------------	--------------------------

Jeg kan selv holde mit barn

<input type="checkbox"/>	<input type="checkbox"/>	<input type="checkbox"/>	<input type="checkbox"/>
--------------------------	--------------------------	--------------------------	--------------------------

Jeg kan passe (eller ville kunne passe) mit barn uden hjælp

<input type="checkbox"/>	<input type="checkbox"/>	<input type="checkbox"/>	<input type="checkbox"/>	<input type="checkbox"/>	<input type="checkbox"/>	<input type="checkbox"/>	<input type="checkbox"/>	<input type="checkbox"/>	<input type="checkbox"/>
--------------------------	--------------------------	--------------------------	--------------------------	--------------------------	--------------------------	--------------------------	--------------------------	--------------------------	--------------------------

Jeg klarer mig selv, herunder personlig hygiejne

<input type="checkbox"/>	<input type="checkbox"/>	<input type="checkbox"/>	<input type="checkbox"/>	<input type="checkbox"/>	<input type="checkbox"/>	<input type="checkbox"/>	<input type="checkbox"/>	<input type="checkbox"/>	<input type="checkbox"/>
--------------------------	--------------------------	--------------------------	--------------------------	--------------------------	--------------------------	--------------------------	--------------------------	--------------------------	--------------------------

Jeg føler, at jeg har kontrol over min situation

<input type="checkbox"/>	<input type="checkbox"/>	<input type="checkbox"/>	<input type="checkbox"/>	<input type="checkbox"/>	<input type="checkbox"/>	<input type="checkbox"/>	<input type="checkbox"/>	<input type="checkbox"/>	<input type="checkbox"/>
--------------------------	--------------------------	--------------------------	--------------------------	--------------------------	--------------------------	--------------------------	--------------------------	--------------------------	--------------------------

Meget enig Hverken eller Meget uenig

Resultater:

Den summerede tilpashedsscore



- Median 73 (IQR 56; 88)
- Range: Min 4; Max 120

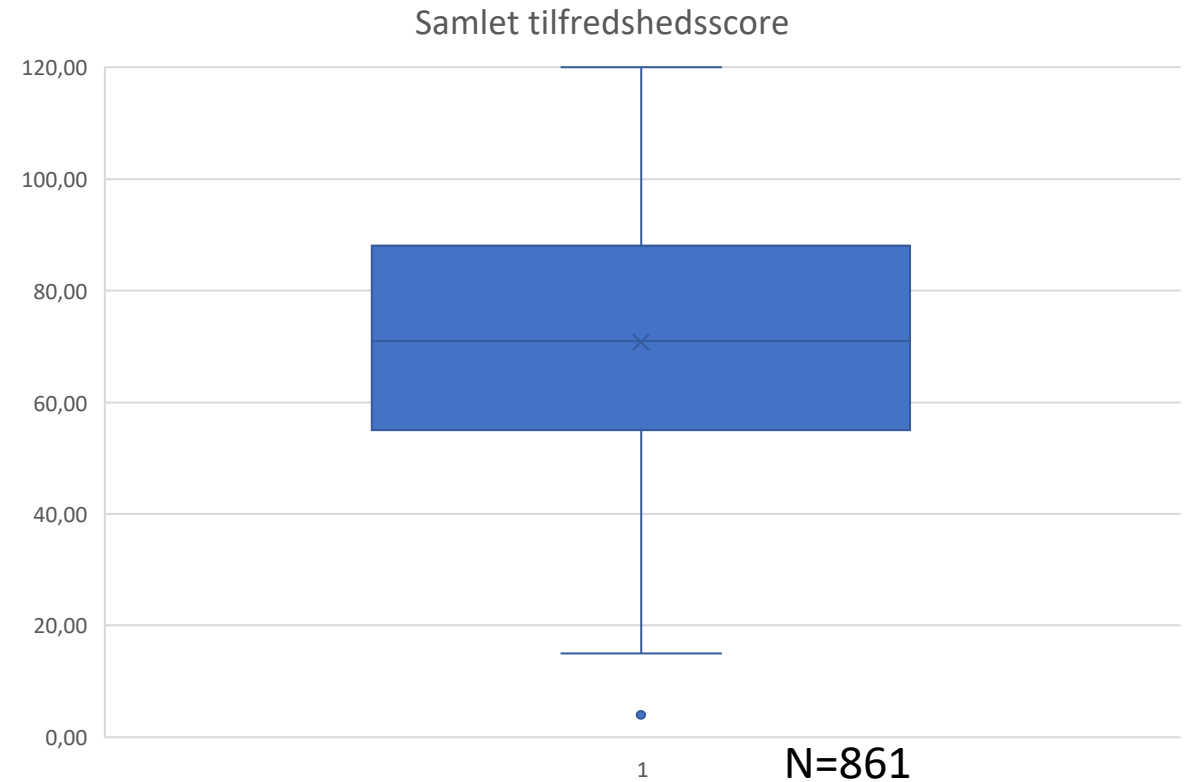

Sammenligning af score

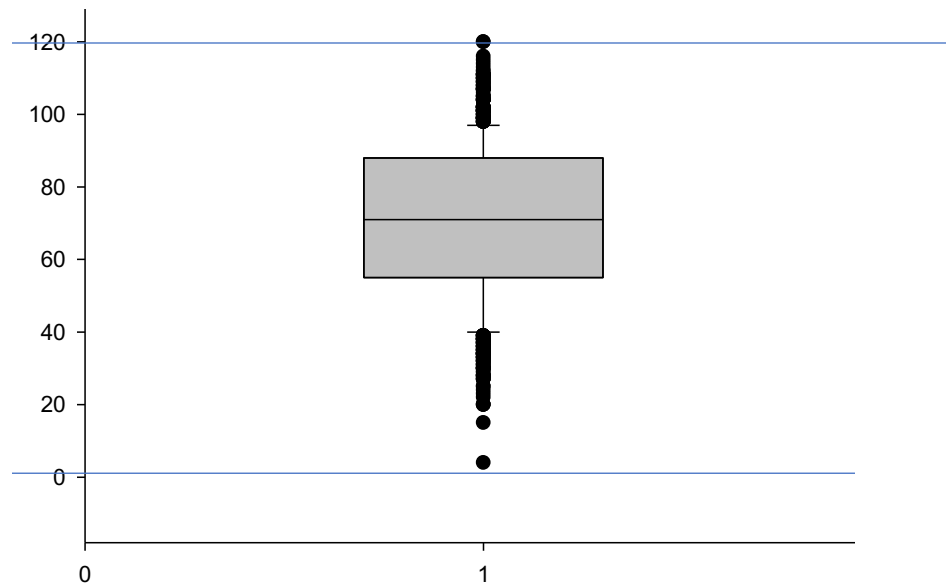
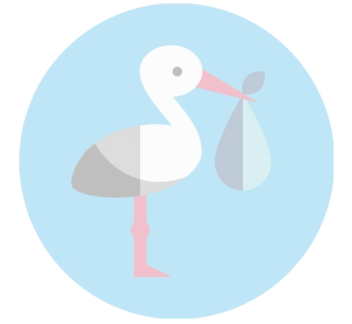

Summeret tilpashedsscore ObsQoR-12

N=861

Sammenligning af score

Tilpashed/Tilfredshed sammenlignet

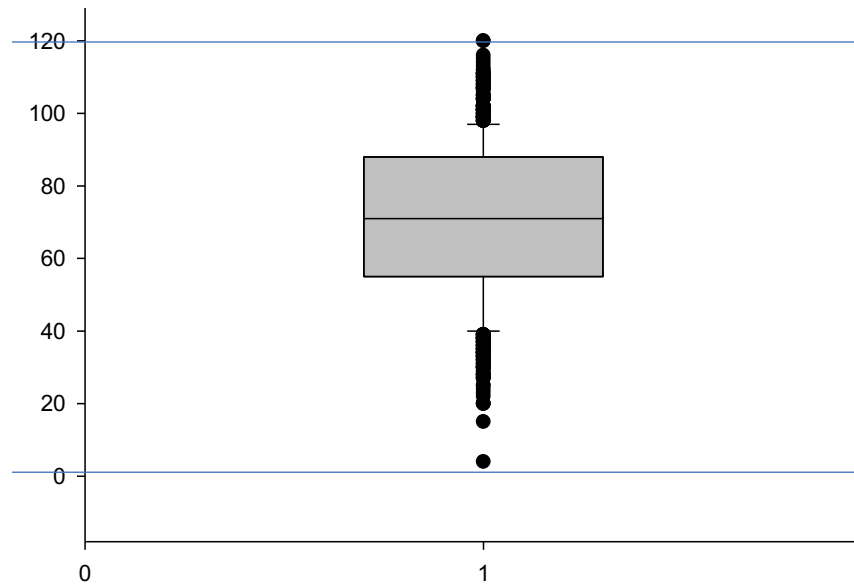

Summeret tilpashedsscore ObsQoR-12

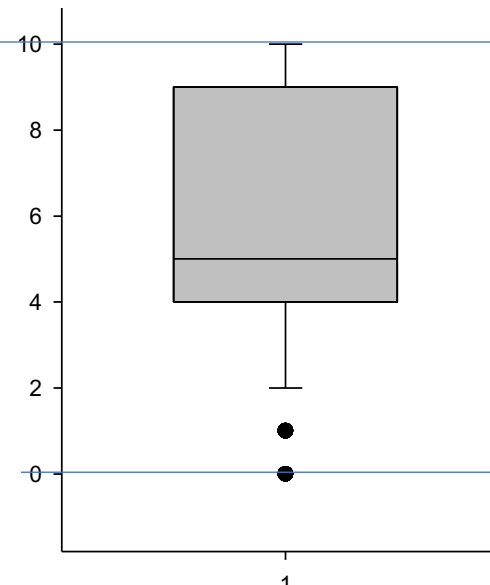

Tilfredshed ift forventning

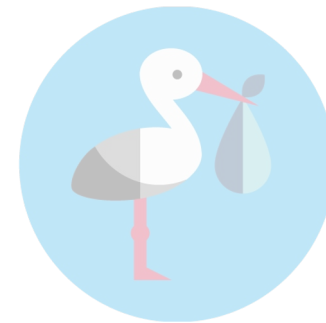

Tilpashed/tilfredshed sammenlignet

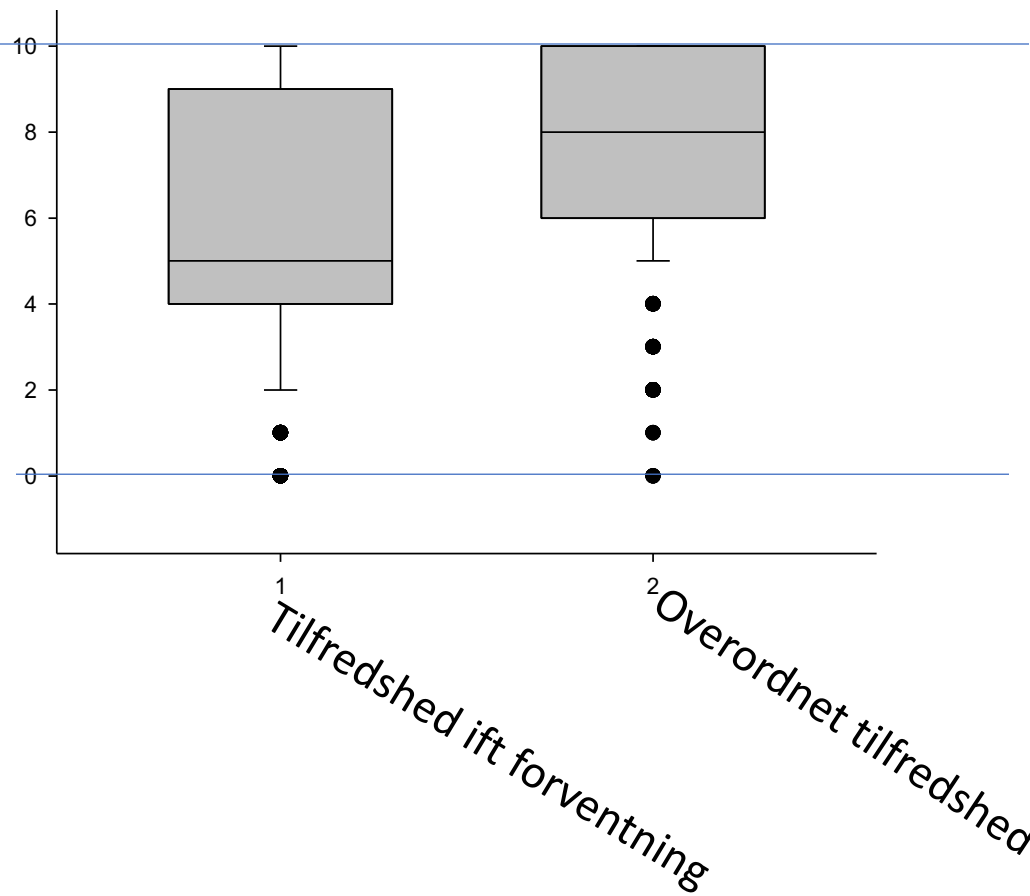
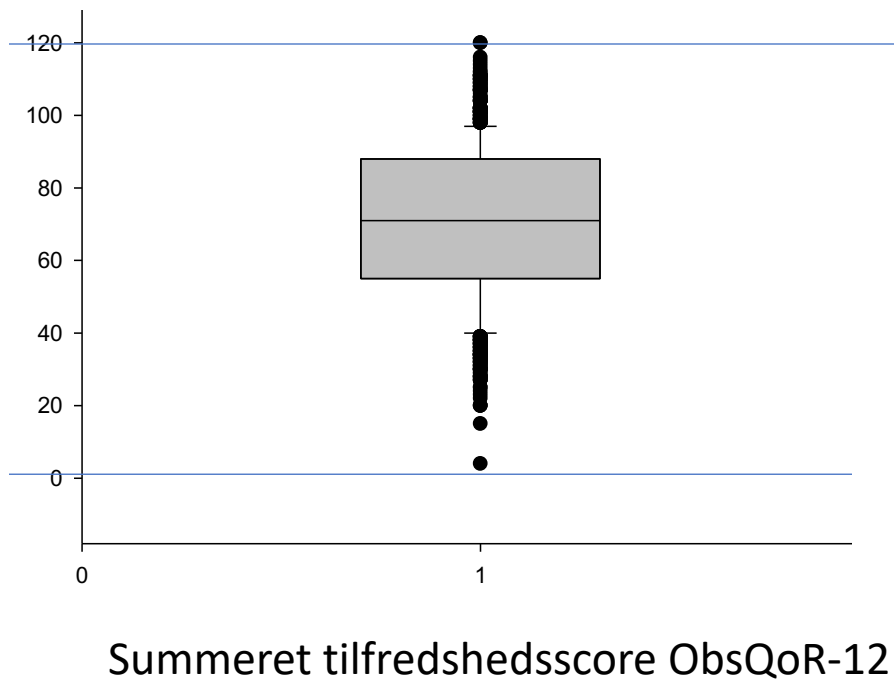

Samlet tilfredshed fordelt på domæner

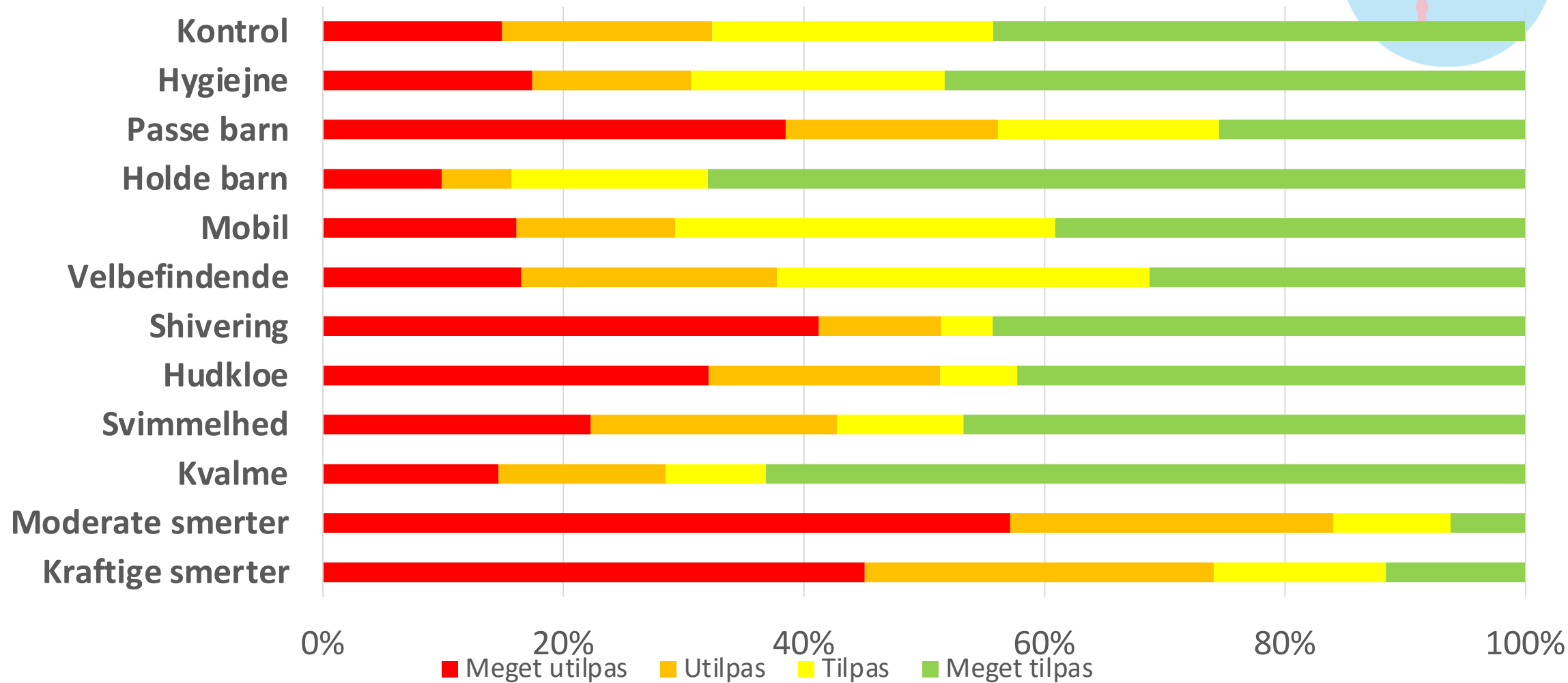
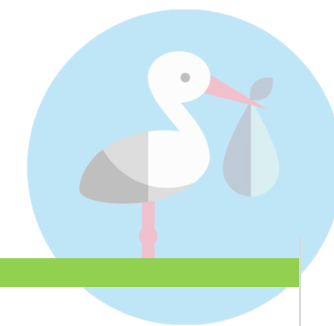

Fordeling af svar indenfor 12 domæner: 0-10 er poolet til 1-4 skala.

Take home

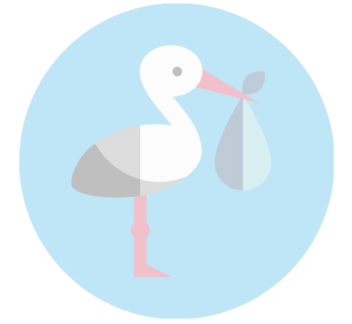

- Doseret medicin skal dokumenteres
- Patienten skal bedøves ordentligt
- Meget stor variation i behovet for opioid efter kejsersnit
- Ca. ½ af kvinder, der har fået lavet kejsersnit, er meget enig i udsagnet 'at have oplevet meget kraftige smerter' ca. 36 timer efter kejsersnittet

Tilfredshedsscore fordelt på fødested

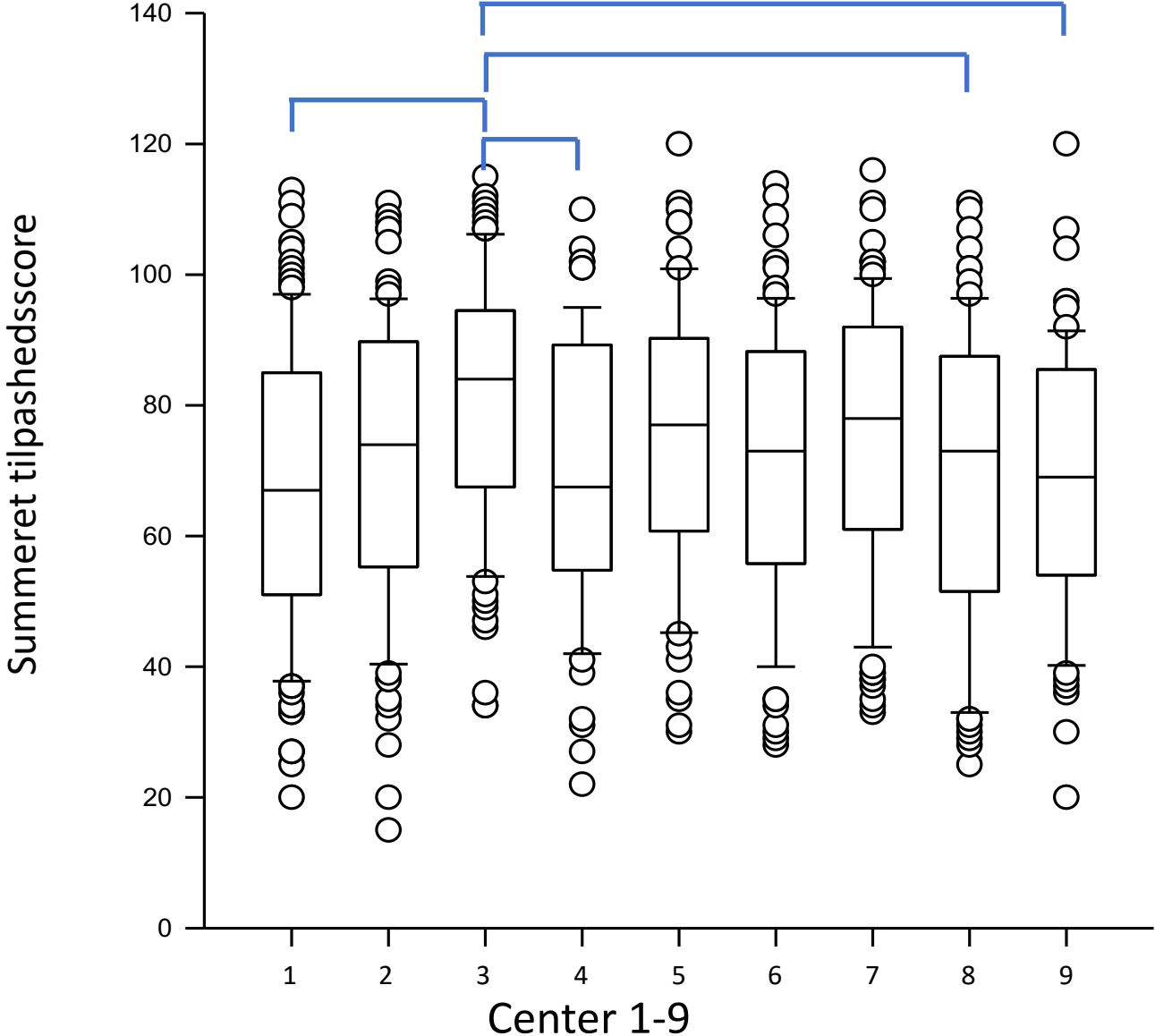
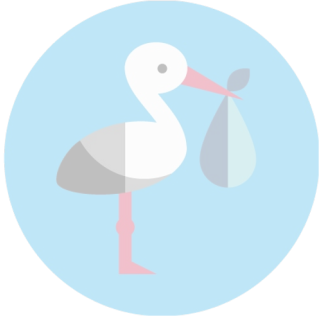

Perspektivering

American Journal of Obstetrics & Gynecology
AJOG MFM
Maternal-Fetal Medicine

Submit

ORIGINAL RESEARCH OBSTETRICS | VOLUME 2, ISSUE 4, 100202, NOVEMBER 01, 2020

Evaluation of inpatient postpartum recovery using the Obstetric Quality of Recovery-10 patient-reported outcome measure: a single-center observational study

Results

Data from 215 women were analyzed. In *hypothesis testing*, the median (interquartile range) Obstetric Quality of Recovery-10 scores were higher following vaginal delivery than cesarean delivery (86 [77–94] vs 77 [64–86], respectively; $P < .001$).

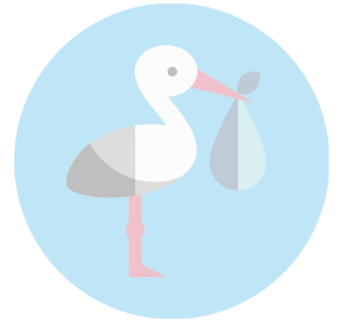

Samlet tilfredshed fordelt på domæner

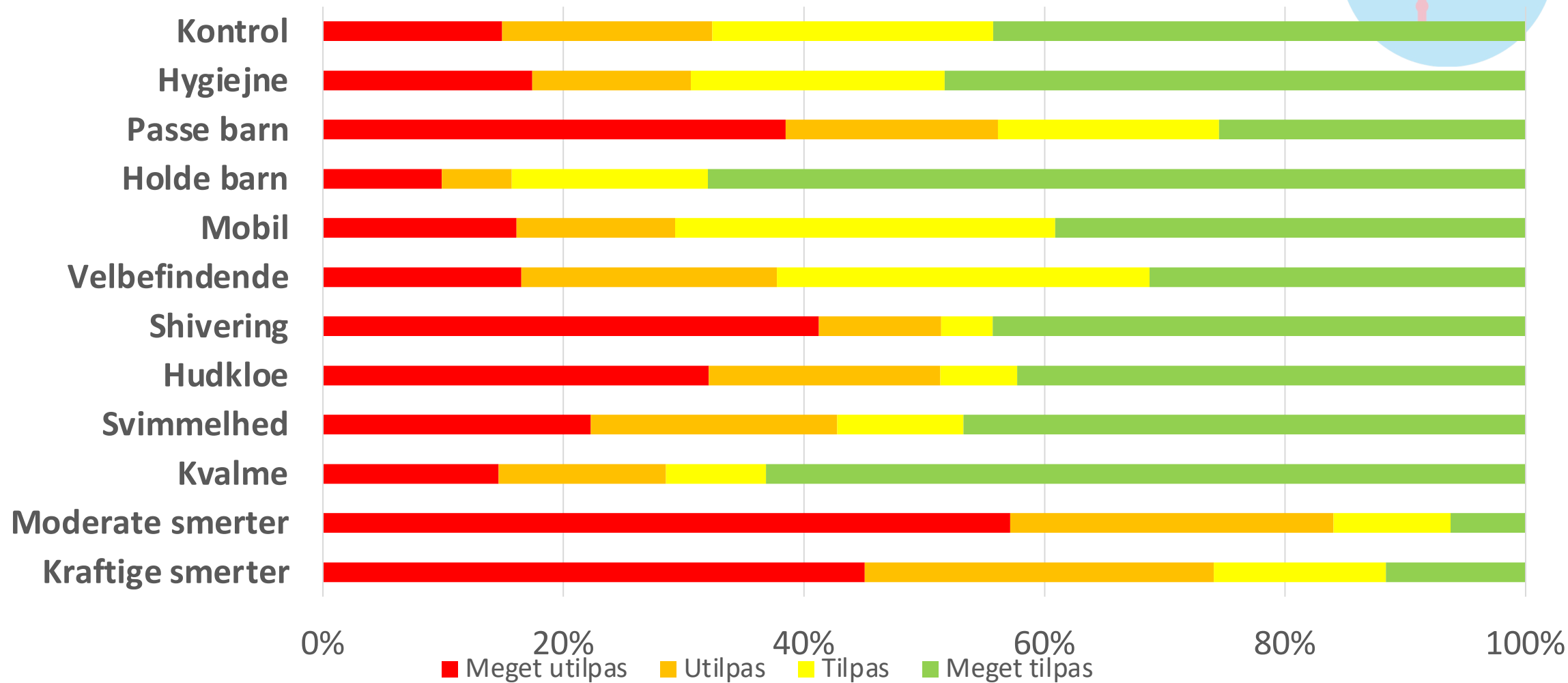
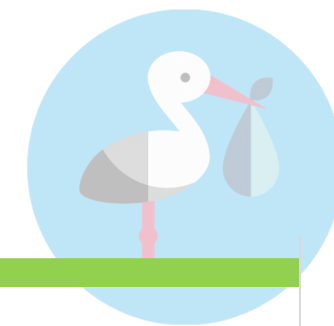

Fordeling af svar indenfor 12 domæner: 0-10 er poolet til 1-4 skala.

Original article



Ultrasound-guided transmuscular quadratus lumborum block for elective cesarean section significantly reduces postoperative opioid consumption and prolongs time to first opioid request: a double-blind randomized trial

Christian K Hansen ¹, Mette Dam ¹, Gudny E Steingrimsdottir ¹, Gunnar Hellmund Laier ², Morten Lebech ³, Troels Dirch Poulsen ¹, Vincent W S Chan ⁴, Morné Wolmarans ⁵, Thomas Fichtner Bendtsen ⁶ and Jens Børglum ¹

University of Copenhagen, DK-4000

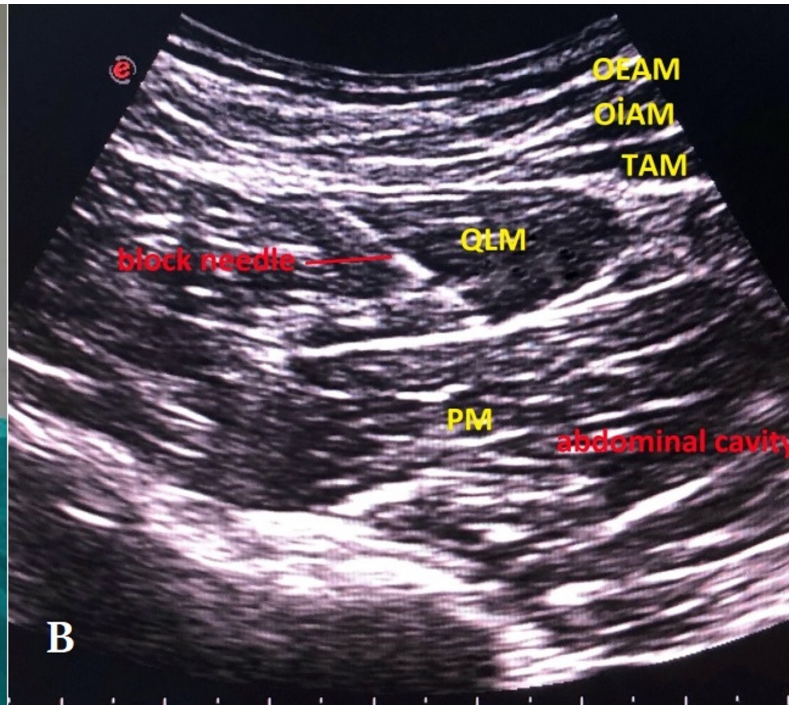

Original article



Ultrasound-guided transmuscular quadratus lumborum block for elective cesarean section significantly reduces postoperative opioid consumption and prolongs time to first opioid request: a double-blind randomized trial

Christian K Hansen¹, Mette Dam¹, Gudny E Steingrimsdottir¹, Gunnar Hellmund Laier², Morten Lebech³, Troels Dirch Poulsen¹, Vincent W S Chan⁴, Morné Wolmarans⁵, Thomas Fichtner Bendtsen⁶ and Jens Børglum¹

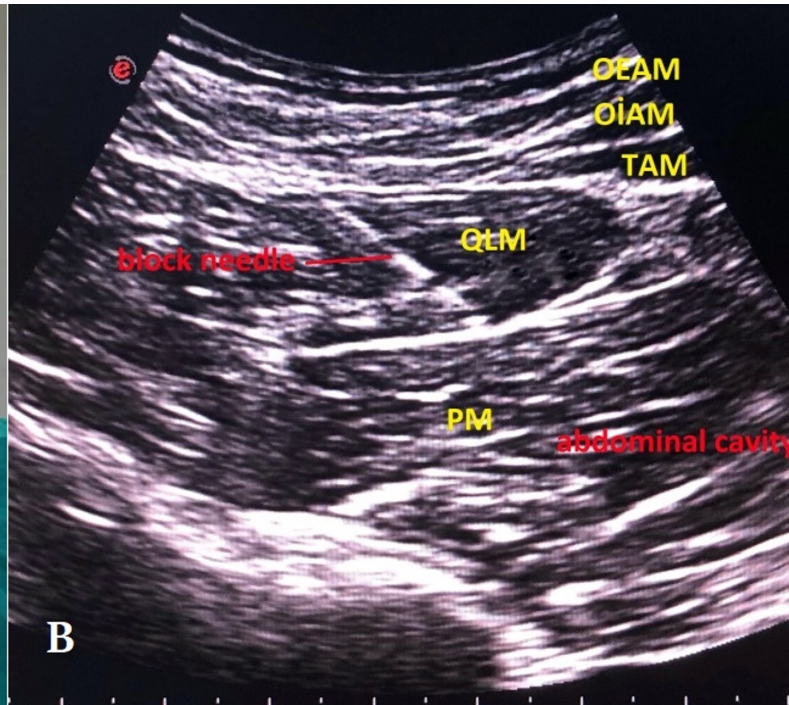



Ultrasound-guided transmuscular quadratus lumborum block for elective cesarean section significantly reduces postoperative opioid consumption and prolongs time to first opioid request: a double-blind randomized trial

Christian K Hansen ¹, Mette Dam ¹, Gudny E Steingrimsdottir ¹, Gunnar Hellmund Laier ², Morten Lebech ³, Troels Dirch Poulsen ¹, Vincent W S Chan ⁴, Morné Wolmarans ⁵, Thomas Fichtner Bendtsen ⁶ and Jens Børglum ¹

Correspondence to Dr Jens Børglum, Department of Anesthesiology, Zealand University Hospital, University of Copenhagen, DK-4000 Roskilde, Denmark; jens.borglum@gmail.com

Primary outcome			
Oral morphine equivalents 0–24, mean (SD)	65.3 (47.9)	94.3 (60.0)	0.03
Secondary outcomes			
Oral morphine equivalents 0–6 hours, mean (SD)	15.3 (17.3)	34.7 (31.2)	<0.003*
Oral morphine equivalents 6–12 hours, mean (SD)	24.9 (19.7)	27.7 (28.6)	n.s.
Oral morphine equivalents 12–18 hours, mean (SD)	13.5 (12.5)	19.9 (15.3)	n.s.
Oral morphine equivalents 18–24 hours, mean (SD)	11.7 (13.7)	12.1 (13.2)	n.s.



The image is a promotional poster for the television series 'Dopesick'. It features the main cast members standing in a line against a dark, teal-toned background. Numerous white, round pills are shown falling through the air, some in sharp focus and others blurred. The title 'DOPESICK' is written in large, white, sans-serif capital letters across the bottom center. The letter 'O' in 'DOPESICK' is replaced by a white pill with a diagonal score line and the number '10' embossed on it. Other pills with the letters 'OC' are visible in the foreground.

DOPESICK

Take home



- Doseret medicin skal dokumenteres
- Patienten skal bedøves ordentligt
- Meget stor variation i behovet for opioid efter kejsersnit
- Ca. ½ af kvinder der har fået lavet kejsersnit er meget enig i udsagnet at have oplevet meget kraftige smerter ca. 36 timer efter kejsersnittet
- Opioid er djævelskab på den lange bane

Intrathecal morfin

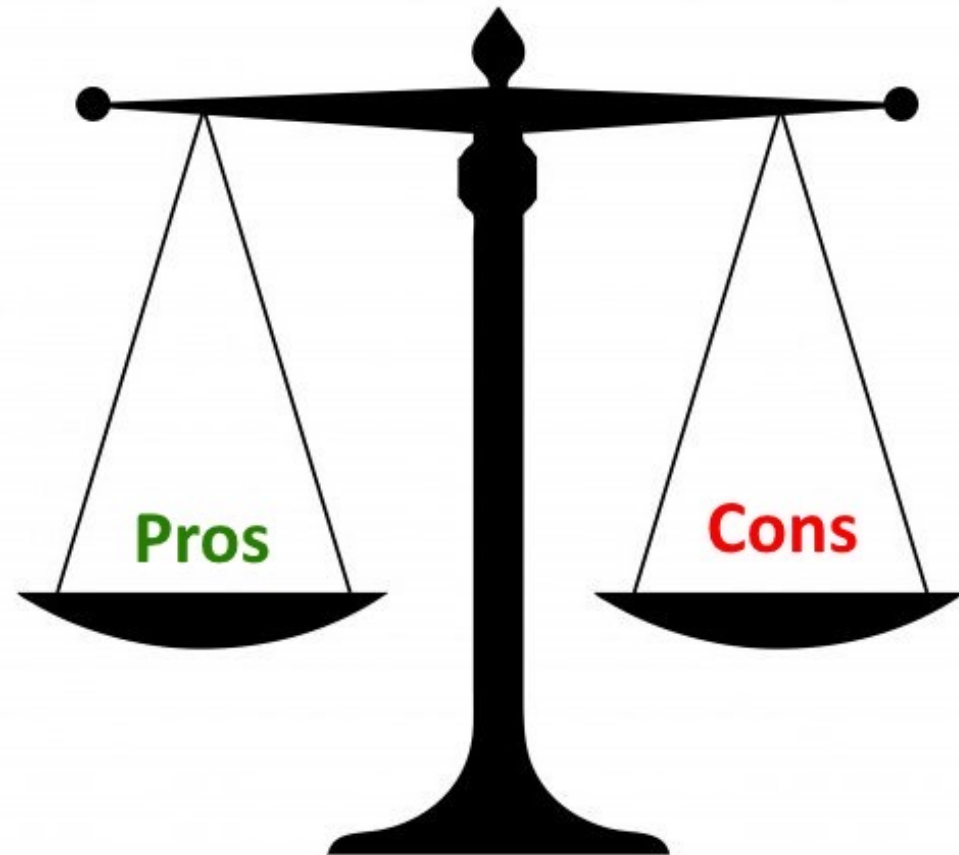

Kvantificering af smerte

- Hvor ondt har du på en skala fra 0-10?

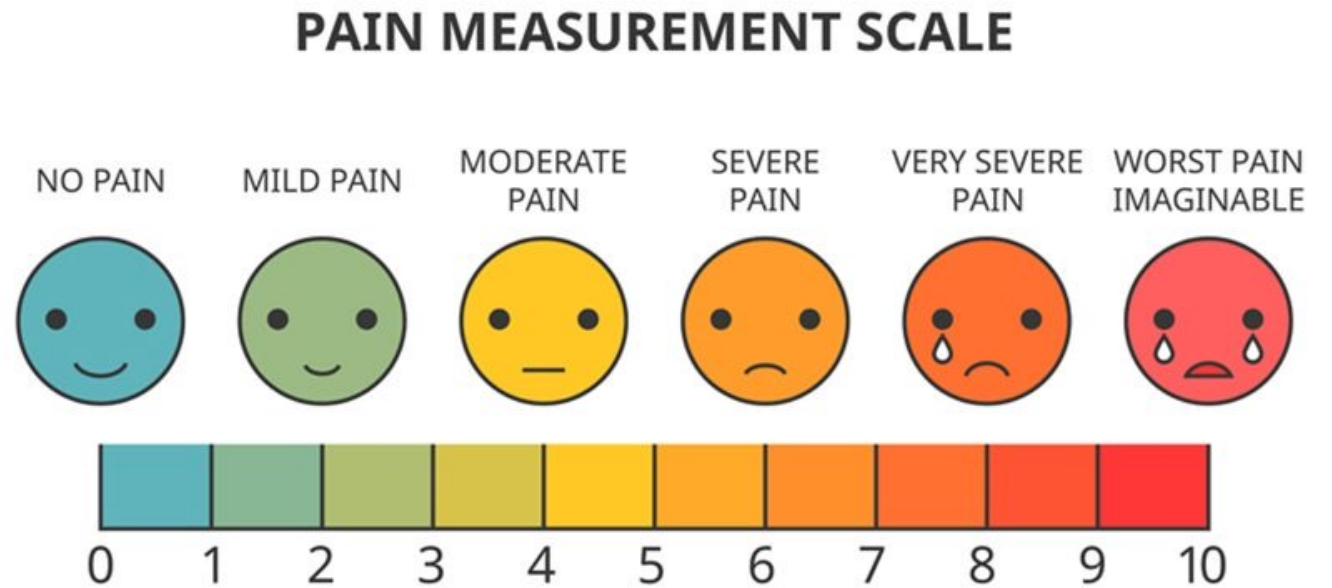

Kvantificering af smerte

- Hvor ondt har du på en skala fra 0-10?

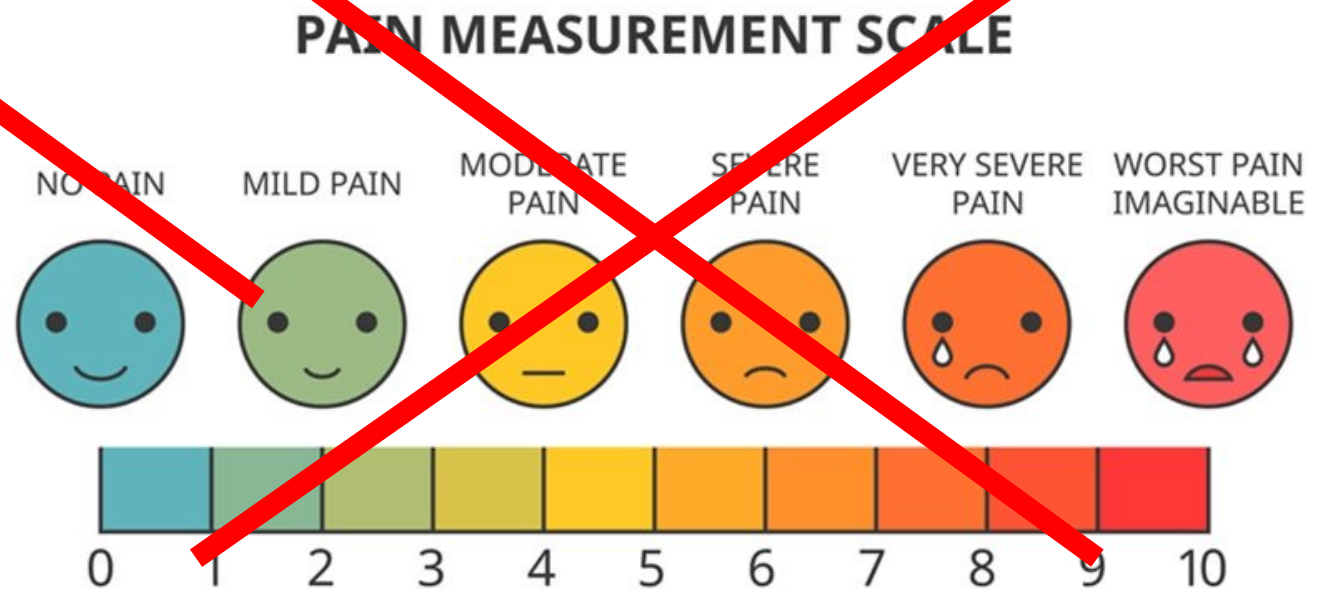

Kvantificering af smerte

- Har du det acceptabelt?



Take home



- Doseret medicin skal dokumenteres
- Patienten skal bedøves ordentligt
- Meget stor variation i behovet for opioid efter kejsersnit
- Ca. ½ af kvinder der har fået lavet kejsersnit er meget enig i udsagnet at have oplevet meget kraftige smerter ca. 36 timer efter kejsersnittet
- Opioid er djævelskab på den lange bane
- Vedr. smerte: anvend IKKE 0-10, spørg om patienten har det acceptabelt

Tidl. sectio og tilfredshed



	Tilfredshedsscore	MW Rank Sum Test
Tidl. Sectio (n=265)	77 (59; 90)	P=0,051
IKKE tidl. Sectio (n=539)	71 (55; 88)	

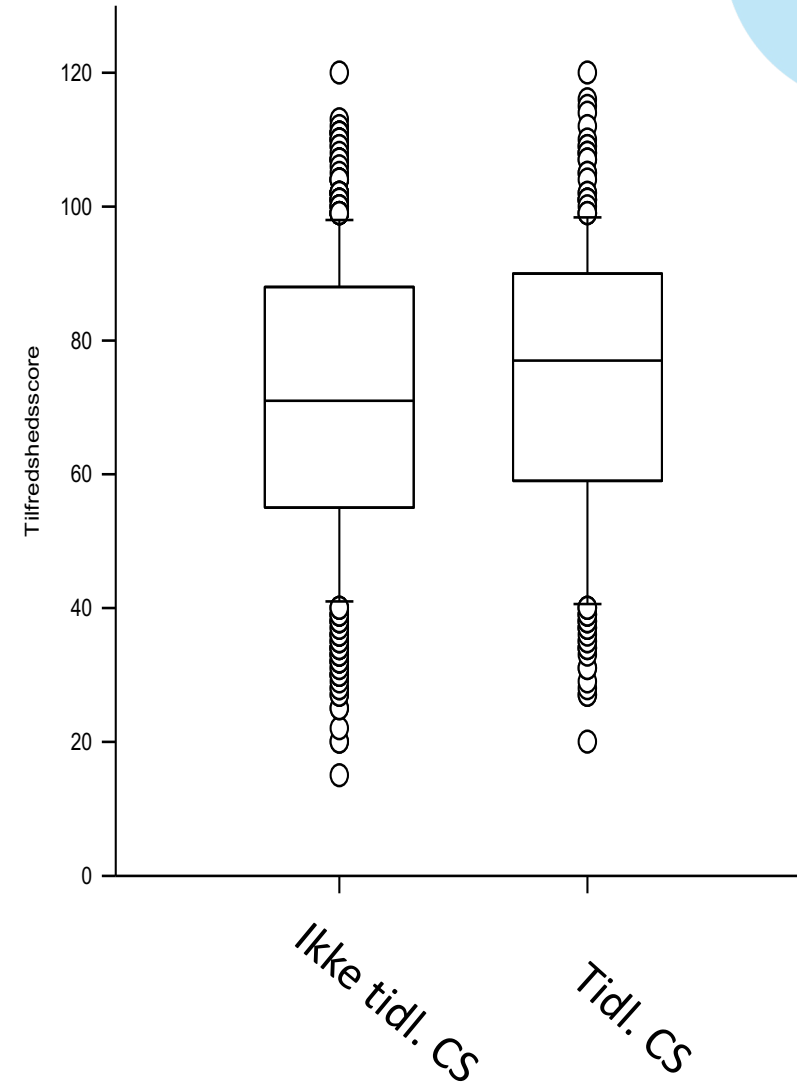

Take home



- Doseret medicin skal dokumenteres
- Patienten skal bedøves ordentligt
- Meget stor variation i behovet for opioid efter kejsersnit
- Ca. ½ af kvinder der har fået lavet kejsersnit er meget enig i udsagnet at have oplevet meget kraftige smerter ca. 36 timer efter kejsersnittet
- Opioid er djævelskab på den lange bane
- Vedr. smerte: anvend IKKE 0-10, spørg om patienten har det acceptabelt
- Bedre information før sectio er nok hensigtsmæssig



Tak for opmærksomheden
og tak for i dag



DASAIM
Tværfagligt
Obstetrisk
Symposium
2023

Send gerne kommentarer og/eller ris og ros

Til

Kim.lindelof@regionh.dk